

**MAL209674821E3**

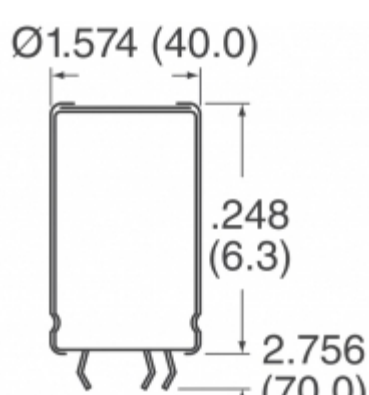

**Part Number:** MAL209674821E3  
**Manufacturer:** Electro-Films (EFI) / Vishay  
**Description:** CAP ALUM 820UF 20% 420V SNAP  
**Data sheet:** [096 PLL-4TSI \(MAL2096\) Series](#)  
[Aluminum Electrolytic Capacitors Guide](#)

**RoHS Status:** Lead free / RoHS Compliant  
**Ship From:** Hong Kong  
**Shipment Way:** DHL/Fedex/TNT/UPS/EMS



[Request For Quotation](#)

**PRODUCT PARAMETER**

<b>Part Number</b>	MAL209674821E3	<b>Manufacturer</b>	<a href="#">Electro-Films (EFI) / Vishay</a>
<b>Description</b>	CAP ALUM 820UF 20% 420V SNAP	<b>Lead Free Status / RoHS Status</b>	Lead free / RoHS Compliant
<b>Quantity Available</b>	5624 pcs	<b>Data sheet</b>	<a href="#">096 PLL-4TSI (MAL2096) Series</a> <a href="#">Aluminum Electrolytic Capacitors Guide</a>
<b>Category</b>	<a href="#">Capacitors</a>	<b>Voltage - Rated</b>	420V
<b>Tolerance</b>	±20%	<b>Surface Mount Land Size</b>	-
<b>Size / Dimension</b>	1.575" Dia (40.00mm)	<b>Series</b>	096 PLL-4TSI
<b>Ripple Current @ Low Frequency 4.7A @ 100Hz</b>		<b>Ratings</b>	-
<b>Polarization</b>	Polar	<b>Packaging</b>	Tape & Box (TB)
<b>Package / Case</b>	Radial, Can - 5 Lead	<b>Operating Temperature</b>	-40°C ~ 85°C
<b>Mounting Type</b>	Through Hole	<b>Moisture Sensitivity Level (MSL)</b>	1 (Unlimited)
<b>Manufacturer Standard Lead Time</b>	21 Weeks	<b>Lifetime @ Temp.</b>	5000 Hrs @ 85°C
<b>Lead Spacing</b>	0.787" (20.00mm)	<b>Lead Free Status / RoHS Status</b>	Lead free / RoHS Compliant
<b>Impedance</b>	74 mOhms	<b>Height - Seated (Max)</b>	2.559" (65.00mm)
<b>ESR (Equivalent Series Resistance)</b>	209 mOhm @ 100Hz	<b>Detailed Description</b>	820µF 420V Aluminum Electrolytic Capacitors Radial, Can - 5 Lead 209 mOhm @ 100Hz 5000 Hrs @ 85°C
<b>Capacitance</b>	820µF	<b>Applications</b>	General Purpose

Component-World.com is a Reliable Stocking Distributor of Electronic Components. We specialize in all Electro-Films (EFI) / Vishay series electronic components. We have 5624 pieces of Electro-Films (EFI) / Vishay MAL209674821E3 in stock available now. Request a quote from electronics components distributor at Component-World.com, our sales team will contact you within 24 hours.  
 RFQ Email: info@Components-World.com

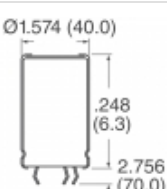
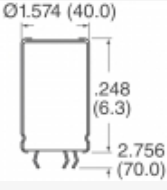
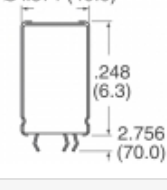
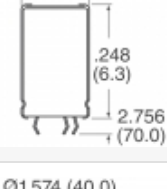
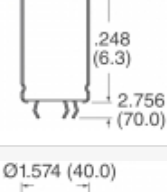
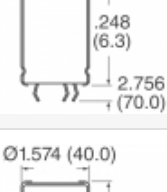
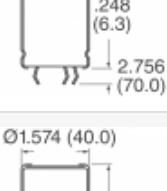
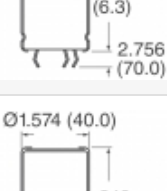
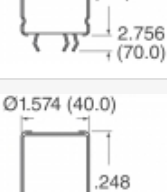
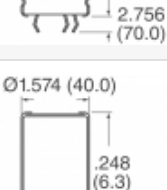
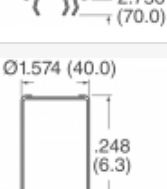
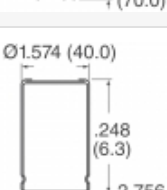
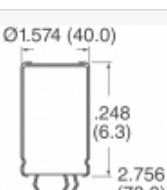
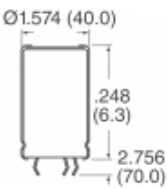
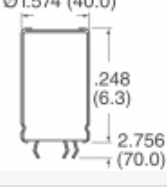
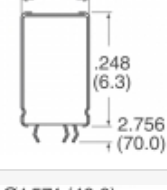
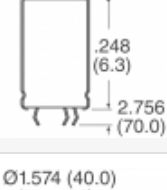
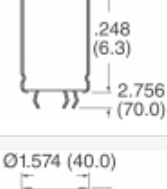
**RELATED PRODUCTS**

	<b>Part#:</b> <a href="#">MAL209675821E3</a> <b>Description:</b> CAP ALUM 820UF 20% 350V SNAP	<b>Manufacturers:</b> <a href="#">Electro-Films (EFI) / Vishay</a>	<a href="#">RFQ</a>
	<b>Part#:</b> <a href="#">MAL209669681E3</a> <b>Description:</b> CAP ALUM 680UF 20% 500V SNAP	<b>Manufacturers:</b> <a href="#">Electro-Films (EFI) / Vishay</a>	<a href="#">RFQ</a>
	<b>Part#:</b> <a href="#">MAL209674122E3</a> <b>Description:</b> CAP ALUM 1200UF 20% 420V SNAP	<b>Manufacturers:</b> <a href="#">Electro-Films (EFI) / Vishay</a>	<a href="#">RFQ</a>
	<b>Part#:</b> <a href="#">MAL209676152E3</a> <b>Description:</b> CAP ALUM 1500UF 20% 400V SNAP	<b>Manufacturers:</b> <a href="#">Electro-Films (EFI) / Vishay</a>	<a href="#">RFQ</a>
	<b>Part#:</b> <a href="#">MAL209675102E3</a> <b>Description:</b> CAP ALUM 1000UF 20% 350V SNAP	<b>Manufacturers:</b> <a href="#">Electro-Films (EFI) / Vishay</a>	<a href="#">RFQ</a>
	<b>Part#:</b> <a href="#">MAL209669821E3</a> <b>Description:</b> CAP ALUM 820UF 20% 500V SNAP	<b>Manufacturers:</b> <a href="#">Electro-Films (EFI) / Vishay</a>	<a href="#">RFQ</a>
	<b>Part#:</b> <a href="#">MAL209675222E3</a> <b>Description:</b> CAP ALUM 2200UF 20% 350V SNAP	<b>Manufacturers:</b> <a href="#">Electro-Films (EFI) / Vishay</a>	<a href="#">RFQ</a>
	<b>Part#:</b> <a href="#">MAL209669471E3</a> <b>Description:</b> CAP ALUM 470UF 20% 500V SNAP	<b>Manufacturers:</b> <a href="#">Electro-Films (EFI) / Vishay</a>	<a href="#">RFQ</a>
	<b>Part#:</b> <a href="#">MAL209675182E3</a> <b>Description:</b> CAP ALUM 1800UF 20% 350V SNAP	<b>Manufacturers:</b> <a href="#">Electro-Films (EFI) / Vishay</a>	<a href="#">RFQ</a>
	<b>Part#:</b> <a href="#">MAL209675122E3</a> <b>Description:</b> CAP ALUM 1200UF 20% 350V SNAP	<b>Manufacturers:</b> <a href="#">Electro-Films (EFI) / Vishay</a>	<a href="#">RFQ</a>
	<b>Part#:</b> <a href="#">MAL209669561E3</a> <b>Description:</b> CAP ALUM 560UF 20% 500V SNAP	<b>Manufacturers:</b> <a href="#">Electro-Films (EFI) / Vishay</a>	<a href="#">RFQ</a>
	<b>Part#:</b> <a href="#">MAL209674681E3</a> <b>Description:</b> CAP ALUM 680UF 20% 420V SNAP	<b>Manufacturers:</b> <a href="#">Electro-Films (EFI) / Vishay</a>	<a href="#">RFQ</a>
	<b>Part#:</b> <a href="#">MAL209674102E3</a> <b>Description:</b> CAP ALUM 1000UF 20% 420V SNAP	<b>Manufacturers:</b> <a href="#">Electro-Films (EFI) / Vishay</a>	<a href="#">RFQ</a>
	<b>Part#:</b> <a href="#">MAL209676182E3</a> <b>Description:</b> CAP ALUM 1800UF 20% 400V SNAP	<b>Manufacturers:</b> <a href="#">Electro-Films (EFI) / Vishay</a>	<a href="#">RFQ</a>
	<b>Part#:</b> <a href="#">MAL209676102E3</a> <b>Description:</b> CAP ALUM 1000UF 20% 400V SNAP	<b>Manufacturers:</b> <a href="#">Electro-Films (EFI) / Vishay</a>	<a href="#">RFQ</a>
	<b>Part#:</b> <a href="#">MAL209674152E3</a> <b>Description:</b> CAP ALUM 1500UF 20% 420V SNAP	<b>Manufacturers:</b> <a href="#">Electro-Films (EFI) / Vishay</a>	<a href="#">RFQ</a>
	<b>Part#:</b> <a href="#">MAL209669391E3</a> <b>Description:</b> CAP ALUM 390UF 20% 500V SNAP	<b>Manufacturers:</b> <a href="#">Electro-Films (EFI) / Vishay</a>	<a href="#">RFQ</a>
	<b>Part#:</b> <a href="#">MAL209674182E3</a> <b>Description:</b> CAP ALUM 1800UF 20% 420V SNAP	<b>Manufacturers:</b> <a href="#">Electro-Films (EFI) / Vishay</a>	<a href="#">RFQ</a>
	<b>Part#:</b> <a href="#">MAL209676122E3</a> <b>Description:</b> CAP ALUM 1200UF 20% 400V SNAP	<b>Manufacturers:</b> <a href="#">Electro-Films (EFI) / Vishay</a>	<a href="#">RFQ</a>
	<b>Part#:</b> <a href="#">MAL209675152E3</a> <b>Description:</b> CAP ALUM 1500UF 20% 350V SNAP	<b>Manufacturers:</b> <a href="#">Electro-Films (EFI) / Vishay</a>	<a href="#">RFQ</a>

**Related keywords for MAL209674821E3**

<a href="#">Electro-Films (EFI) / Vishay MAL209674821E3</a>	<a href="#">MAL209674821E3 distributor</a>	<a href="#">MAL209674821E3 supplier</a>	<a href="#">MAL209674821E3 price</a>
<a href="#">MAL209674821E3 download datasheet</a>	<a href="#">MAL209674821E3 datasheet</a>	<a href="#">MAL209674821E3 stock</a>	<a href="#">buy MAL209674821E3</a>
<a href="#">Electro-Films (EFI) / Vishay MAL209674821E3</a>	<a href="#">Electro-Films (EFI) / Vishay MAL209674821E3</a>	<a href="#">Vishay Electro-Films MAL209674821E3</a>	<a href="#">Phoenix Passive Components / Vishay MAL209674821E3</a>